

IBM 2200VA LCD 2U Rack Uninterruptible Power Supply for IBM System x

IBM System x at-a-glance guide

The IBM 2200VA LCD 2U Rack uninterruptible power supply (UPS) delivers 1920 watts of power in only 2U of rack space, providing smart energy management and the highest level of power protection that today's IT infrastructures require. With an efficiency rating of 95% or greater, the UPS helps reduce energy usage and cooling costs, improves energy management, and optimizes workload performance and availability for IBM System x and BladeCenter server applications. This high-density UPS packs more real power (watts) into a space-saving 2U of rack space to protect more equipment and leaves room for expanding IT systems.

The IBM 2200VA LCD 2U Rack UPS is shown in Figure 1.



Figure 1. IBM 2200VA LCD 2U Rack UPS for IBM System x

Did You Know?

The IBM 2200VA UPS has a bright, easily customizable, and graphical LCD display that lets you configure the device and displays important UPS status information in one of nine languages (English, French, German, Spanish, Russian, Korean, Japanese, Simplified Chinese, and Traditional Chinese). The UPS is exceptionally easy to manage and an ideal solution for standardization across the global enterprise.

This UPS enhances system availability with Advanced Battery Management (ABM) technology, which significantly extends battery service life, allows individual control of receptacle groups to maximize run time for critical devices in the event of a prolonged power outage, and provides a real-time clock that enables precise shutdown and power up of systems in a preferred sequence, and records specific power-related occurrences for more accurate trending and data analyses.

The IBM 2200VA UPS integrates with IBM Systems Director Active Energy Manager to help improve energy management..

About uninterruptible power supplies

An uninterruptible power supply (UPS) is a device that acts as a defensive barrier between electronic equipment and incoming power problems. It conditions, regulates, and filters out power disturbances to ensure a clean power source for IT equipment. A UPS also provides battery backup in the event of a power failure.

In today's high availability server environments, unplanned power outages or line quality irregularities can have a considerable financial impact on all sized businesses. The typical utility power is 99.9% available, but that means that there can be almost 9 hours of downtime a year, not to mention brown-outs and other power quality problems.

Selecting the right IBM UPS can help protect against these potentially costly incidents.

Part number information

Table 1 shows the orderable part numbers and feature codes for the IBM 2200VA UPS.

Table 1. Ordering part numbers and feature codes

Description	Part number	Feature code
IBM 2200VA LCD 2U Rack UPS (100V/120V)	5395-2AX	5395-RU2 (FC 6655)
IBM 2200VA LCD 2U Rack UPS (230V)	5395-2KX	5395-RU2 (FC 6656)
IBM 2200VA UPS 2U External Battery Module (EBM)	46M4108	5395-RU2 (FC 5732)
IBM LCD UPS Network Management Card (optional)	46M4110	6145
IBM LCD UPS Environmental Monitoring Probe (optional)	46M4113	6146

The UPS models designated by part numbers 5395-2AX and 5395-2KX include the following items:

- An accessory kit, containing the following items:
 - Front bezel
 - Rack mount kit with rails and hardware
 - Rack installation instructions
 - Serial cable (3.7 m, 12 ft)
 - USB cable
 - 4-post rail kit
 - Remote emergency power-off (REPO) connector
- A documentation kit, containing the following items:
 - Warranty flyer
 - Important Notices Manual
 - Documentation CD
 - Software CD, which contains IBM UPS Manager power management software

The 100V/120V model includes a IEC 320 C19 to NEMA 5-20P 4.3 m line cord, but other customer ordered line cords can be used.

The line cords for the 230V model must be ordered separately. See Table 2 for available options.

Table 2. High voltage line cords

2.8 m line cords	Part number
European 10A line C13 to CEE 7/7 (2.8 m)	39Y7917
Denmark 10A line C13 to DK2-5A (2.8 m)	39Y7918
Switzerland 10A line C13 to SEV 1011 (2.8 m)	39Y7919
Israel 10A line C13 to SI 32 (2.8 m)	39Y7920
Italy 10A line C13 to CEE 7/7 (2.8 m)	39Y7921
South Africa 10A line C13 to SABS 164/1 (2.8 m)	39Y7922
United Kingdom 10A line C13 to BS 1363 (2.8 m)	39Y7923
Australia/NZ 10A line C13 to SAA-AS C112 (2.8 m)	39Y7924
Korea 7A line C13 to KETI 15A/250V (2.8 m)	39Y7925
India 6A line C13 to Fig 68 (2.8 m)	39Y7927
China 6A line C13 to GB 2099.1 (2.8 m)	39Y7928
Taiwan 10A/125V C13/CNS 10917 (2.8 m)	81Y2374
Taiwan 10A/250V C13/CNS 10917 (2.8 m)	81Y2375
Brazil 10A/250V C13 to NBR 14136 (2.8 m)	69Y1988
Argentina 10A line C13 to IRAM 2063 (2.8 m)	39Y7930
4.3 m line cords	Part number
Europe 10A/250V C13 / CEE 7/7 (4.3 M)	81Y2376
United Kingdom 10A/250V C13 / BS 1363A (4.3 m)	81Y2377
China 10A/250V C13 / GB2099.1 (4.3 m)	81Y2378
South Africa 10A/250V C13/ SANS 164-1 (4.3 m)	81Y2379
Italy 10A/250V C13/ CEI 23-16 (4.3 m)	81Y2380
Israel 10A/250V C13/ SI 32 (4.3 m)	81Y2381
Denmark 10A/250V C13/SB107-2-DI (4.3 m)	81Y2382
Australia 10A/250V C13/ AS/NZS 3112/2000 (4.3 m)	81Y2383
Argentina 10A/250V C13/ IRAM 2073 (4.3 m)	81Y2384
Korea 12A/250V C13/KSC 8305 (4.3 m)	81Y2385
India 10A/250V C13/IS 6538 (4.3 m)	81Y2386
Brazil 10A/250V C13/ NBR 14136 (4.3 m)	81Y2387
Taiwan 10A/125V C13/CNS 10917 (4.3 m)	81Y2388
Taiwan 10A/250V C13/CNS 10917 (4.3 m)	81Y2389
Switzerland 10A/250V C13/SEV 1011 (4.3 m)	81Y2390

Features

The IBM 2200VA LCD 2U Rack UPS includes the following features and capabilities:

- It has a high efficiency 2.2 KVA UPS for increased rack power density.
- It occupies only 2U of vertical rack space.
- It has over 95% energy efficiency at 100% load.
- It has an LCD display that provides intuitive, at-the-rack management and monitoring capabilities that supports nine languages:
 - English.
 - French.
 - German.
 - Spanish.
 - Russian.
 - Korean.
 - Japanese.
 - Simplified Chinese.
 - Traditional Chinese.
- It has 10 receptacles:
 - Model 5395-2AX (100V/120V) has six NEMA 5-20R, two IEC 320 C19, and two IEC 320 C13.
 - Model 5395-2KX (230V) has two IEC 320 C19 and eight IEC 320 C13.
- Its bundled intelligent IBM UPS Manager software enhances control and manageability
- It has IPv6 compliance for future proofing IP addressing and security.
- It has a real-time clock that enables precise shutdown and power up of systems in preferred sequence and time stamping on event logs to track and record specific power-related occurrences.
- It integrates with IBM Systems Director Active Energy Manager for power and thermal trending analysis and management.
- Its load segments allow for individual control of receptacle groups, maximizing run time for critical devices.
- It has an optional network management card (part number 46M4140) for enhanced UPS monitoring and control.
- It allows dual channel communication through the USB port and optional Network Management Card at the same time, which is an effective redundancy feature that maximizes communications flexibility.
- It has an optional Extended Battery Module (EBM) for increased runtime requirements.
- It has a Remote Emergency Power Off (REPO) port to remotely power off the UPS unit to prevent battery operation during a power failure.
- It requires a 20A (110V/120V model) or 10A (230V model) single-phase circuit.
- It has hot swap batteries for maximum uptime, availability, and ease of maintenance.
- It has an optional Environmental Monitoring Probe (part number 46M4113) for thermal management requirements (temperature and humidity), which requires that the Network Management Card be installed.
- Its Advanced Battery Management (ABM) three-stage charging technology significantly extends battery service life and optimizes recharge time. The three stages are:
 1. The battery is quickly charged to 90% to make sure the UPS is prepared for the next outage.
 2. ABM finishes charging the battery with a more moderate float charge.
 3. Once the battery is charged, ABM turns the charger off, preventing the batteries from being overcharged.

Specifications

Table 3 lists the specifications for the two 2200VA LCD 2U Rack UPS models.

Table 3. Specifications (Part 1)

Specification	IBM 2200VA LCD 2U Rack UPS (100V/120V)	IBM 2200VA LCD 2U Rack UPS (230V)
IBM part number	5395-2AX	5395-2KX
VA/Watts rating	1920 VA/1920W (120V) 1500 VA/1500W (100V)	2200 VA/1920W
Nominal output voltage (Vac)	100/120V AC	230V AC
Load groups	Two	Two
Output connections	Six NEMA 5-20R Two IEC 320 C19 Two IEC 320 C13	Two IEC 320 C19 Eight IEC 320 C13
Nominal output voltage regulation	92-108V (100V) 106-132V (120V)	208-253V (230V)
Input		
Nominal input voltage (auto sensing at first power-up)	100/120V	230V
Input frequency (auto sensing)	50/60 Hz +/- 3 Hz	50/60 Hz +/- 3 Hz
Input connection Type	IEC 320-C20	IEC 320-C14
Input cords	IEC 320 C19 to NEMA 5-20P 4.3 m	Optional country specific line cords (See Table 2)
Input voltage range, mains operations	84-121V for 100V 97-145V for 120V	160V-286V for 230V
Batteries		
Typical backup times	See Table 4	See Table 5
Battery type	Valve Regulated Lead Acid (VRLA) - maintenance-free, sealed, leak-proof	
Optional External Battery Pack	Yes, 46M410. Maximum of one EBM can be connected to the UPS.	
Typical recharge time	4 hours to 90% charge from a UPS/battery discharge of 50% rated load	

Table 3. Specifications (continued)

Specification	IBM 2200VA LCD 2U Rack UPS (100V/120V)	IBM 2200VA LCD 2U Rack UPS (230V)
Communications and management		
USB HID port	Yes	Yes
RS-232 serial port	Yes	Yes
Ethernet port	Optional using Network Management Card, 46M4110	
Environmental Monitoring Probe	Optional Environmental Monitoring Probe, 46M4113	
Management software included	IBM UPS Manager	
Control panel	Intelligent three-button, dual color, backlit graphical LCD displays vital UPS status in nine languages	
Audible alarm	Alarm when on battery: Distinctive low-battery alarm	
Remote Power Off (REPO)	REPO port	
Surge Protection and Filtering		
Surge energy rating	1200 Joules	2400 Joules
Filtering	ANSI/IEEE C62.41; 1991 CATEGORYB3 (SURGE)	

The following tables list the expected period that the UPS will operate solely on batteries. Table 4 is for the 100V/120V model and Table 5 is for the 230V model.

Table 4. IBM 2200VA UPS (100V/120V) runtime chart

Load			Run time on batteries	
Load (%)	Load (VA)	Load (Watts)	Run time with standard internal battery only	Run time with internal battery plus External Battery Module (EBM)
25%	500 VA	500 W	42 minutes	143 minutes
50%	969 VA	969 W	14 minutes	66 minutes
75%	1450 VA	1450 W	11 minutes	43 minutes
100%	1920 VA	1920 W	5 minutes	28 minutes

Table 5. IBM 2200VA UPS (230V) runtime chart

Load			Run time on batteries	
Load (%)	Load (VA)	Load (Watts)	Run time with standard internal battery only	Run time with internal battery plus External Battery Module (EBM)
25%	550 VA	500 W	41 minutes	138 minutes
50%	1100 VA	968 W	14 minutes	64 minutes
75%	1650 VA	1450 W	10 minutes	40 minutes
100%	2200 VA	1920 W	5 minutes	28 minutes

Note: Battery backup times are approximate and may vary with equipment, configuration, battery age, and temperature.

Physical specifications

- Height: 84 mm (3.3 in)
- Width: 438 mm (17.2 in)
- Depth: 580 mm (22.8 in)
- Weight: 30.5 kg (67.1 lb) / 53952KX - 30.7 kg (67.6 lb)

Operating environment

The IBM 2200VA LCD 2U Rack UPS is supported in the following environment:

- Temperature:
 - Operation: 0 to 40 °C (32 to 104 °F)
 - Storage: -15° to 30° C (5° to 86° F) - charge the UPS battery every six months
 - Storage: 30° to 45° C (86° to 113° F) - charge the UPS battery every three months
- Relative humidity: 5 to 95%
- Maximum altitude:
 - Operation: 3,000 m (10,000 ft)
 - Storage: 15,000 m (50,000 ft)

Warranty

The IBM 2200VA LCD 2U Rack UPS has a three-year limited warranty.

Supported rack installation

The IBM 2200VA LCD 2U Rack UPS requires 2U of rack space in one of the following rack cabinets:

- IBM 42U Enterprise rack
- IBM S2 42U Dynamic rack
- IBM S2 42U rack
- IBM S2 25 U rack
- IBM 11U Office Enablement kit

Front panel controls

With a bright and easy-to-navigate panel that provides configurability and displays important status information, the IBM 2200VA UPS is easy to manage and an ideal solution for standardization across the global enterprise. Runtime, load, and other vital information and troubleshooting are also displayed.

Figure 2 shows the front panel of the UPS.

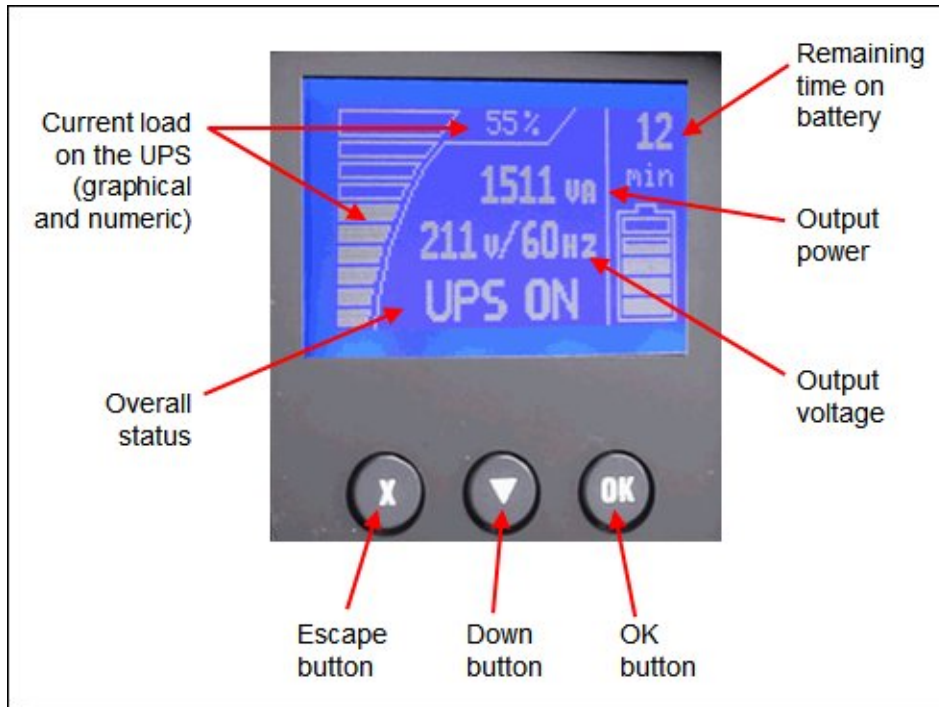

Figure 2. Front panel (showing System Status)

The following functions are available on the control panel:

- System status: Displays the battery status, load percentage, output power, output voltage and frequency, mode, notice or alarm status.
- Alarm history: Displays the alarm history for the 50 most recent events.
- Meters: Displays the output watts VA, current, power factor, voltage, frequency, input voltage, input frequency, battery voltage and percentage charged.
- Control screens: Displays the battery test, reset error state, configure load segments, and restore settings.
- Model information: Displays the machine type, model, and serial number of the unit as well as the firmware level of the UPS, including the optional Network Management Card's firmware level and IP address, if installed.
- Configuration: Allows you to change up to 17 user settings with minimal navigation.

The buttons have the following functions:

- Escape (X): Press this button to return to the previous menu without running a command or saving any changes.
- Down (▼): Press this button to scroll down to the next menu option.
- OK: Press this button to select the current menu or option.
- On/off: Press this button to turn on the UPS. Press and hold this button for 3 seconds to turn off the UPS.

On some screens, the OK button has an additional function if you press and hold the button longer than 1 second:

- On the User Setting screens, to save the displayed setting.
- On the Meter and Notice/Alarm screens, to lock the screen (prevent the screen from returning to its default after timeout). A locked screen displays a small key image near the status icon. To unlock the screen, press any button to perform its usual function.

Rear panel

Figure 3 shows the rear panel of the IBM 2200VA LCD 2U Rack UPS (100V/120V).

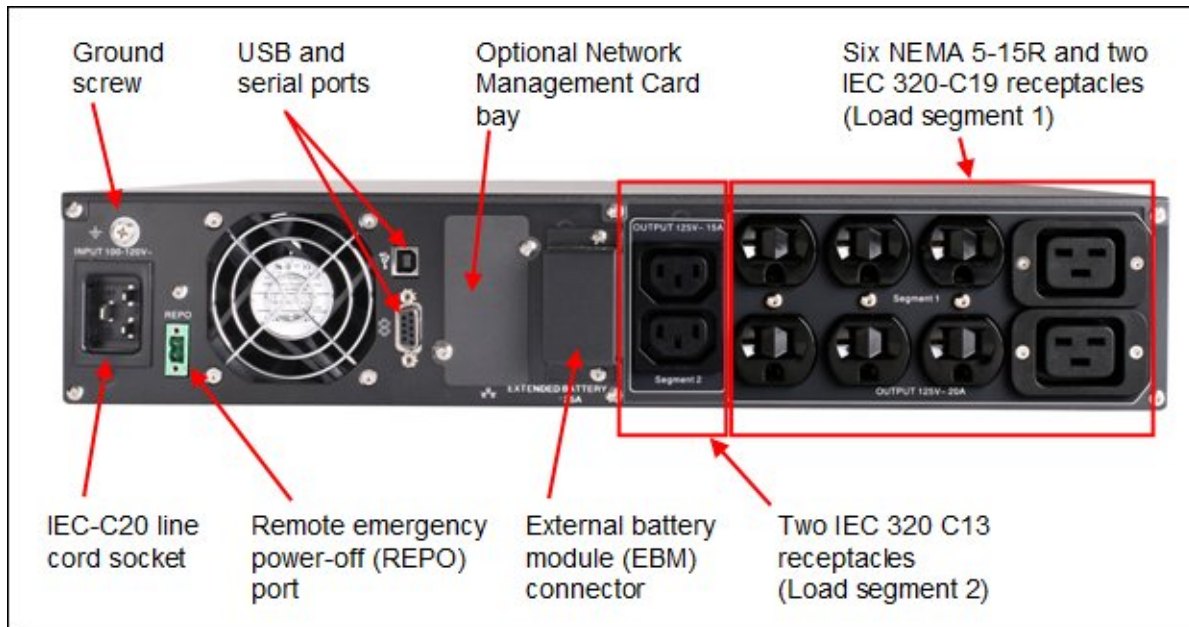

Figure 3. Rear panel of the IBM 2200VA LCD 2U Rack UPS (100V/120V)

Figure 4 shows the rear panel of the IBM 2200VA LCD 2U Rack UPS (230V).

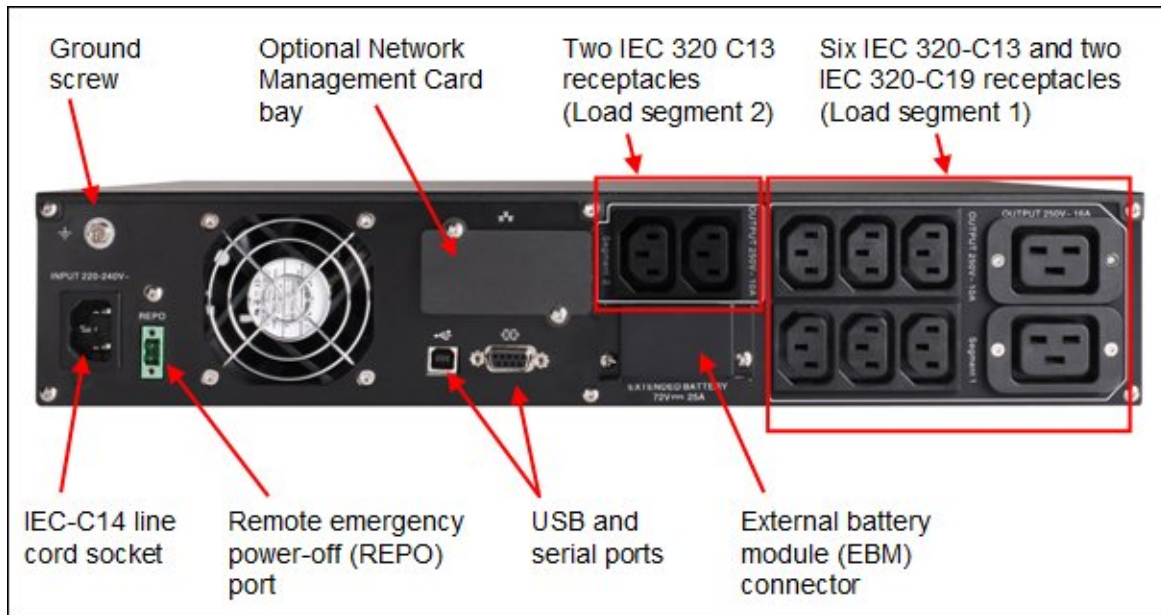

Figure 4. Rear panel of the IBM 2200VA LCD 2U Rack UPS (230V)

The 2200VA UPS comes equipped with intelligent load segments. These individual receptacle groups can be programmed and controlled allowing mission critical devices to be prioritized during shutdown to preserve battery run time. An external battery module can also be added to deliver hours of run time to critical systems during a prolonged power outage.

IBM 2U Extended Battery Module (EBM)

For applications requiring extended backup times, an external battery module can be added to run connected systems for hours during a prolonged power outage. The IBM 2U Extended Battery Module (EBM) is a 2U rack-mounted device that contains additional batteries. Tables 4 and 5 show the additional run times achieved with the EBM connected. Figure 5 shows the front of the 2U External Battery Module.



Figure 5. IBM 2U Extended Battery Module (EBM)

Network Management Card

The IBM 2200VA LCD 2U Rack UPS also comes equipped with a communication bay for the installation of an optional Network Management Card (46M4110). The Network Management Card provides convenient over the network UPS remote monitoring and management through a standard web browser. Figure 6 shows the IBM LCD UPS Network Management Card (NMC).



Figure 6. IBM LCD UPS Network Management Card (NMC)

The IBM LCD UPS Network Management Card:

- Allows simultaneous shutdown of protected servers
- Allows configuration of automatic email messages in response to UPS alarms and to transmit periodic reports (see Figure 7)
- Allows control of UPS on/off switching with a web browser
- Allows adjustment and control of load segments through the HTML interface, including sequential starting of the installation and optimization of backup time by shutting down non-priority systems
- Allows protection by using an encrypted password
- Allows protection by using a secure SSL connection
- Allows log storage in the nonvolatile memory
- Allows card firmware updates through the network
- Allows fast Ethernet 10/100 Mbps compatibility with auto-negotiation on the RJ-45 connector
- Allows recording of events and measurements in the card log
- Has a humidity/temperature/dry contact sensor (optional EMP)
- Has support for IPv6
- Can be installed while the UPS is online maintaining the highest system availability

Figure 7 shows the Network Management Card properties window.

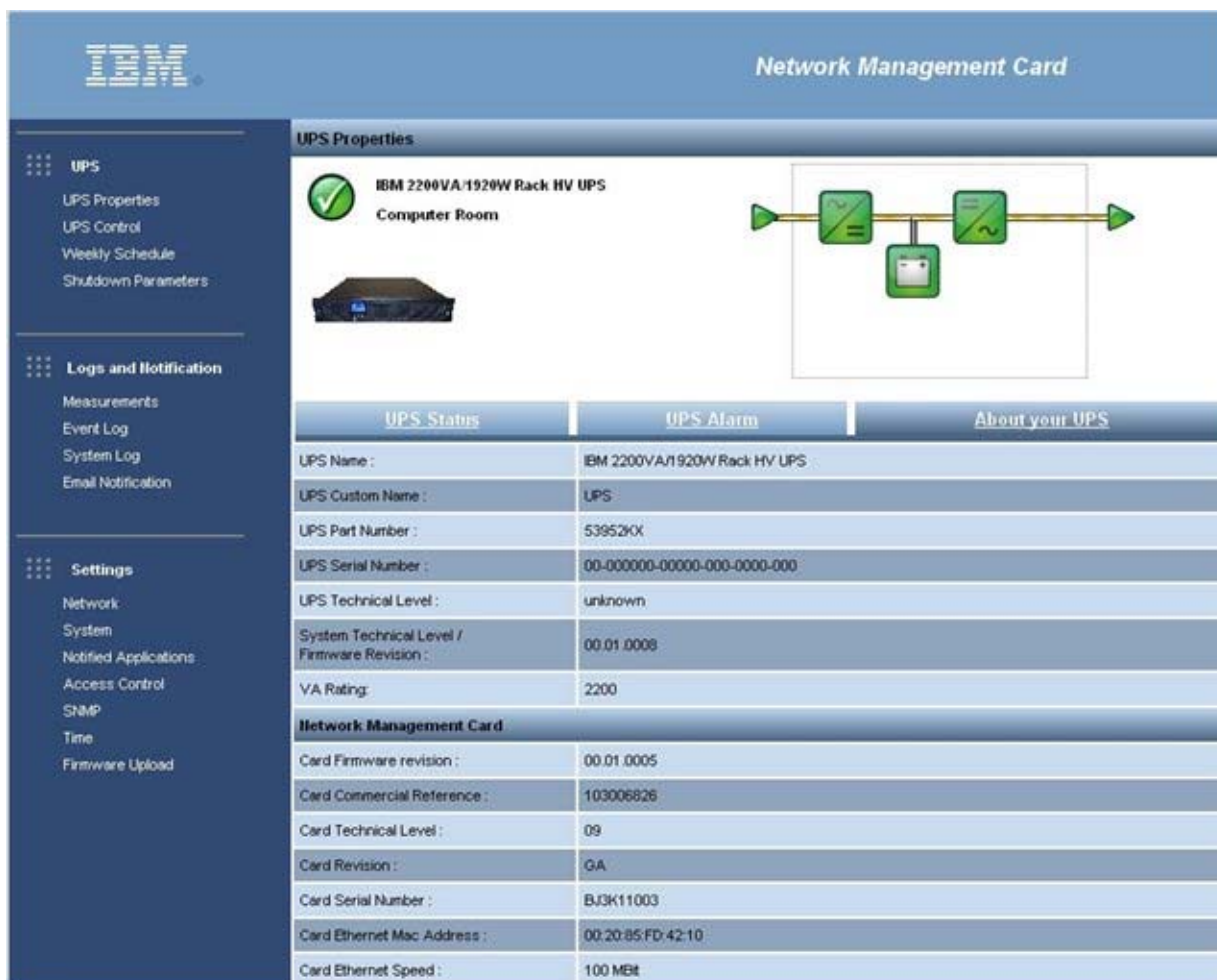

Figure 7. IBM LCD UPS Network Management Card (NMC) properties window

IBM UPS Manager software

The UPS comes with the IBM UPS Manager software. The management software provides up-to-date graphics of UPS power and system data and power flow. It also gives you a complete record of critical power events, and notifies you of important UPS or power information. If there is a power outage and the UPS battery power becomes low, the software can automatically shut down the system to protect the data before the UPS shutdown occurs.

Figure 8 shows normal operating using the IBM UPS Manager. The input voltage is 122V, which is within the acceptable range, and is shown in the left pane. The output voltage of the UPS is 121V and is also within the acceptable range. The battery is in "floating" mode, which is the second stage of the Eaton Advanced Battery Management (ABM) three-stage charging technology.

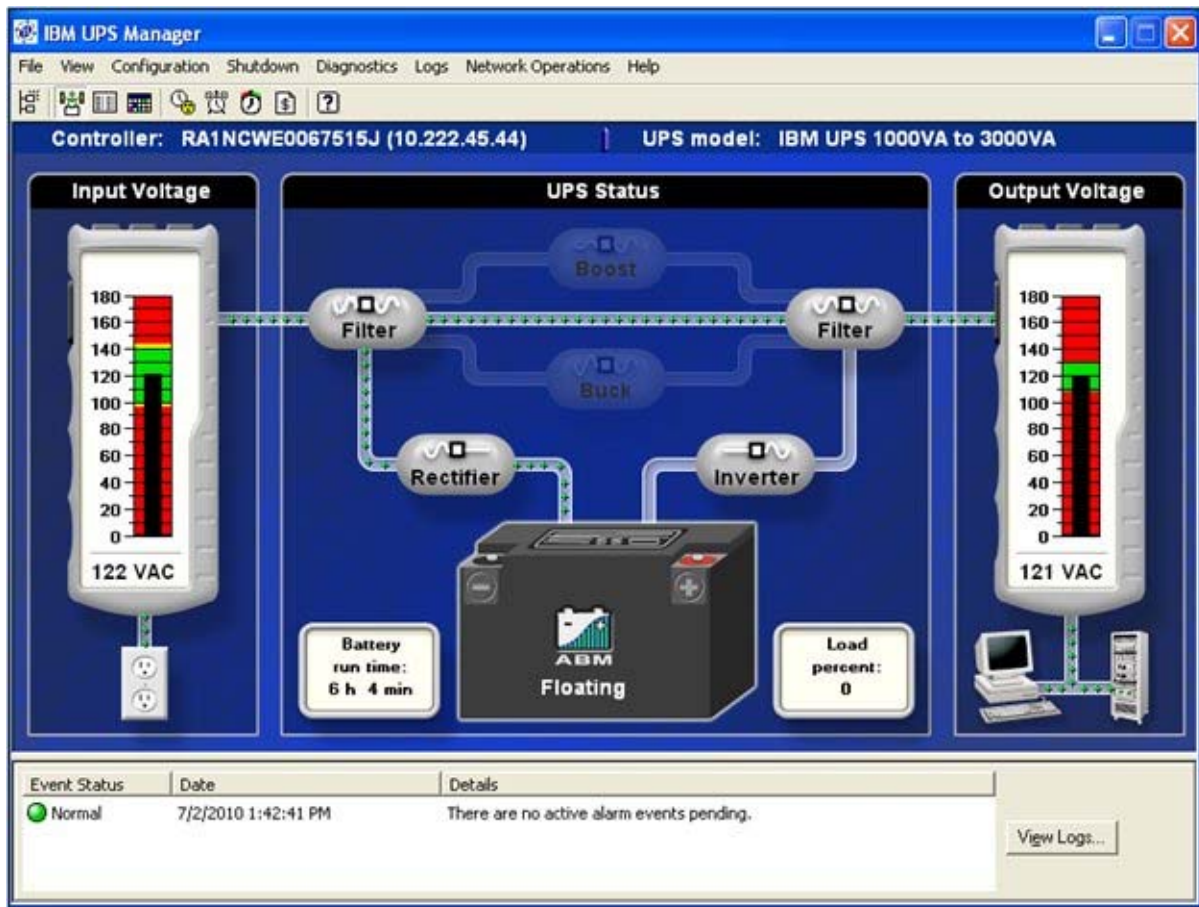

Figure 8. IBM UPS Manager normal status window

Figure 9 shows that the utility power supply has failed and that the UPS is now operating on battery. The UPS Manager software indicates that there is 10 minutes of battery time available based on the current load.

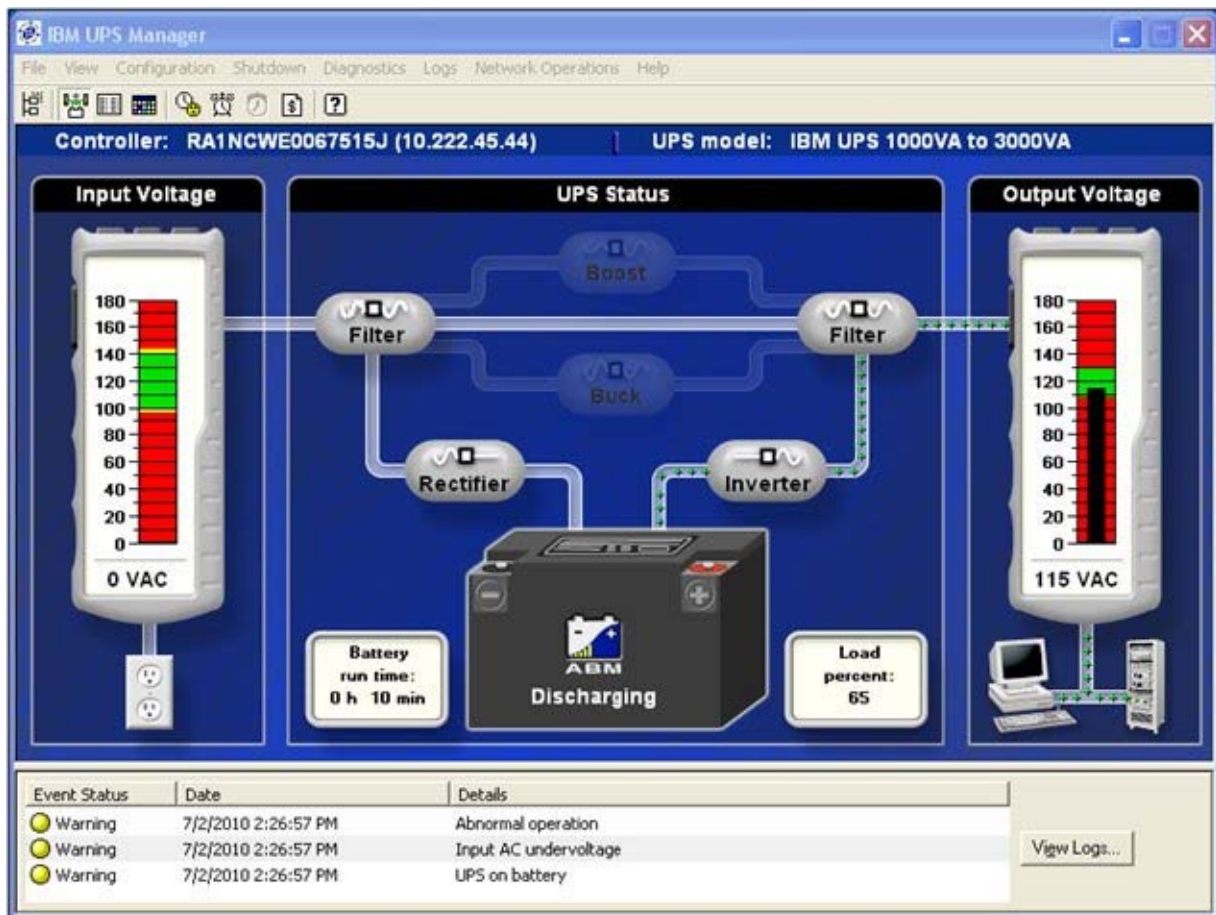

Figure 9. IBM UPS Manager warning status window

Figure 10 shows the event notification window where you can configure how you (and other users) want to be notified when certain events occur.

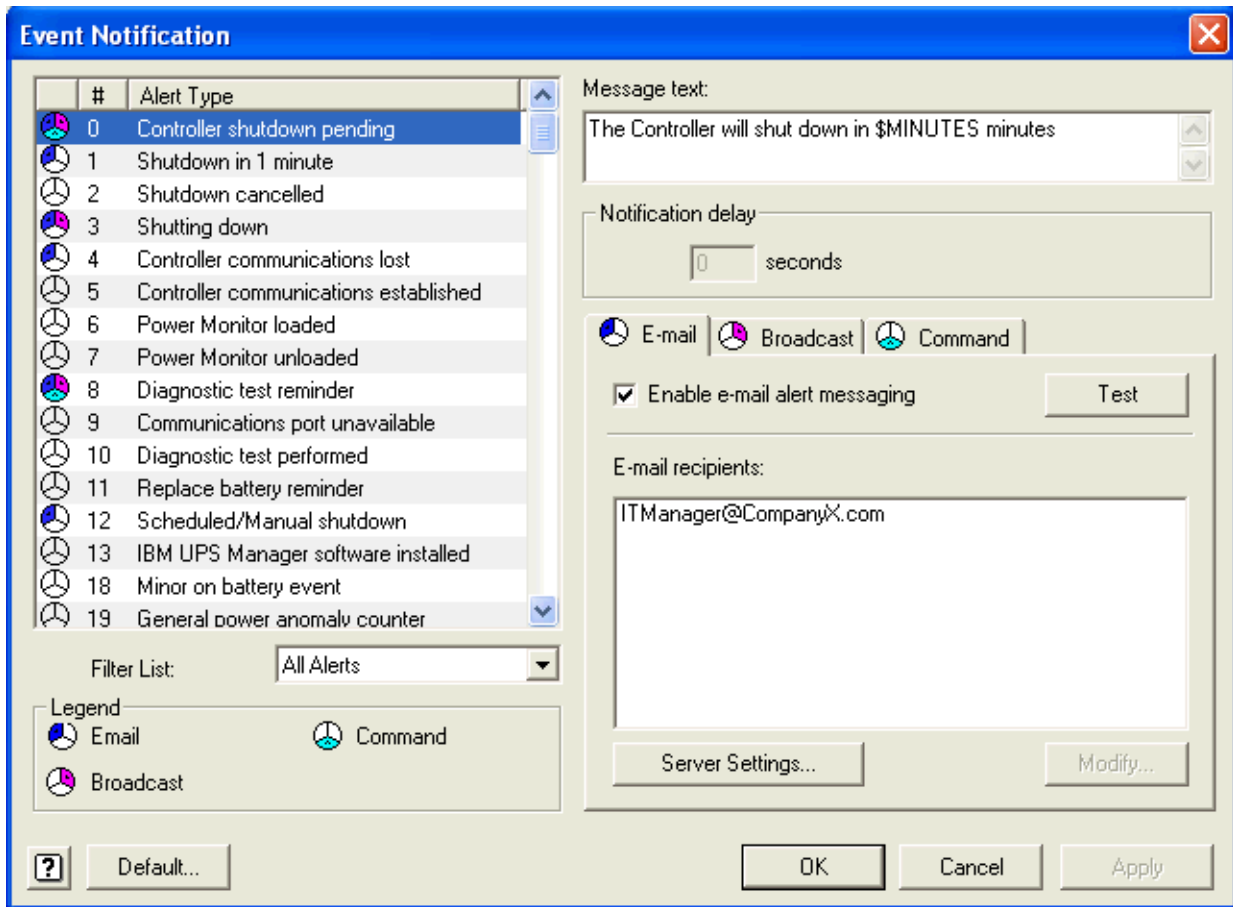

Figure 10. Event Notification window

IBM Environmental Monitoring Probe (EMP)

The Environmental Monitoring Probe (EMP) (part number 46M4113) is used to report local temperature and humidity values and make that information available to management tools such as IBM Systems Director Active Energy Manager (AEM). The EMP connects to the UPS via the Network Management Card. The EMP is shown in Figure 11.



Figure 11. IBM Environmental Monitoring Probe (EMP)

The Environmental Monitoring Probe has the following characteristics:

- It connects to the Network Management Card (NMC) settings/sensor connection.
- Its temperature and humidity thresholds are easily set to trigger alarm notifications or shut down the protected system.
- Its status can be monitored from the IBM Systems Director AEM or from the Network Management Card web interface.
- It measures temperatures between 0 and 80°C (32 and 176°F) with an accuracy of $\pm 1^{\circ}\text{C}$.
- It measures relative humidity between 10 and 90% with an accuracy of $\pm 5\%$.
- It can be located away from the UPS with a CAT5 network cable (up to 20 m (65.6 ft)).
- Its user-selectable alarm thresholds enable you to define acceptable temperature or humidity limits.
- It allows email notification through SMTP.

Figure 12 shows information retrieved from an EMP using the NMC web interface.



Figure 12. Environmental Monitoring Probe data as viewed from the Network Management Card web interface

IBM Systems Director Active Energy Manager

IBM Systems Director Active Energy Manager (AEM) provides an array of new features that allow power and thermal trending analysis for improved power management. AEM collects power information for each device attached to an IBM UPS, presenting a more complete view of energy usage within the data center.

The IBM Systems Director Active Energy Manager (AEM) helps:

- Collect power information from each device attached to an IBM UPS, thus presenting a more complete view of energy usage.
- With server consolidation plans, because of the increased server and rack power densities that have driven the requirement for advanced power management solutions.
- In combination with the optional Environmental Monitoring Probe, AEM enables cross-platform power and thermal trending analysis for improved power management. This configuration allows IT and facility managers to manage data centers for optimal energy efficiency, migrate workloads to eliminate hot spots, and transfer work from underutilized systems to conserve energy.

Related publications

For more information, refer to these documents:

- IBM US Product Announcement
<http://ibm.com/common/ssi/cgi-bin/ssialias?infotype=dd&subtype=ca&&htmlfid=897/ENUS110-159>
- IBM System x UPS product page
<http://www.ibm.com/systems/x/hardware/options/upsrack.html>
- *IBM 2200VA LCD 2U Rack Uninterruptible Power Supply Installation and Maintenance Guide*
<http://www.ibm.com/support/docview.wss?uid=psg1MIGR-5085198>
- *Network Management Card User Guide*
<http://www.ibm.com/support/docview.wss?uid=psg1MIGR-5085199>
- *IBM System x Configuration and Options Guide*
<http://www.ibm.com/support/docview.wss?uid=psg1SCOD-3ZVQ5W>

Notices

This information was developed for products and services offered in the U.S.A.

IBM may not offer the products, services, or features discussed in this document in other countries. Consult your local IBM representative for information on the products and services currently available in your area. Any reference to an IBM product, program, or service is not intended to state or imply that only that IBM product, program, or service may be used. Any functionally equivalent product, program, or service that does not infringe any IBM intellectual property right may be used instead. However, it is the user's responsibility to evaluate and verify the operation of any non-IBM product, program, or service. IBM may have patents or pending patent applications covering subject matter described in this document. The furnishing of this document does not give you any license to these patents. You can send license inquiries, in writing, to:

IBM Director of Licensing, IBM Corporation, North Castle Drive, Armonk, NY 10504-1785 U.S.A.

The following paragraph does not apply to the United Kingdom or any other country where such provisions are inconsistent with local law: INTERNATIONAL BUSINESS MACHINES CORPORATION PROVIDES THIS PUBLICATION "AS IS" WITHOUT WARRANTY OF ANY KIND, EITHER EXPRESS OR IMPLIED, INCLUDING, BUT NOT LIMITED TO, THE IMPLIED WARRANTIES OF NON-INFRINGEMENT, MERCHANTABILITY OR FITNESS FOR A PARTICULAR PURPOSE. Some states do not allow disclaimer of express or implied warranties in certain transactions, therefore, this statement may not apply to you. This information could include technical inaccuracies or typographical errors. Changes are periodically made to the information herein; these changes will be incorporated in new editions of the publication. IBM may make improvements and/or changes in the product(s) and/or the program(s) described in this publication at any time without notice.

Any references in this information to non-IBM Web sites are provided for convenience only and do not in any manner serve as an endorsement of those Web sites. The materials at those Web sites are not part of the materials for this IBM product and use of those Web sites is at your own risk. IBM may use or distribute any of the information you supply in any way it believes appropriate without incurring any obligation to you. Information concerning non-IBM products was obtained from the suppliers of those products, their published announcements or other publicly available sources. IBM has not tested those products and cannot confirm the accuracy of performance, compatibility or any other claims related to non-IBM products. Questions on the capabilities of non-IBM products should be addressed to the suppliers of those products. This information contains examples of data and reports used in daily business operations. To illustrate them as completely as possible, the examples include the names of individuals, companies, brands, and products. All of these names are fictitious and any similarity to the names and addresses used by an actual business enterprise is entirely coincidental.

Any performance data contained herein was determined in a controlled environment. Therefore, the results obtained in other operating environments may vary significantly. Some measurements may have been made on development-level systems and there is no guarantee that these measurements will be the same on generally available systems. Furthermore, some measurement may have been estimated through extrapolation. Actual results may vary. Users of this document should verify the applicable data for their specific environment.

COPYRIGHT LICENSE:

This information contains sample application programs in source language, which illustrate programming techniques on various operating platforms. You may copy, modify, and distribute these sample programs in any form without payment to IBM, for the purposes of developing, using, marketing or distributing application programs conforming to the application programming interface for the operating platform for which the sample programs are written. These examples have not been thoroughly tested under all conditions. IBM, therefore, cannot guarantee or imply reliability, serviceability, or function of these programs.

© Copyright International Business Machines Corporation 2010. All rights reserved.

Note to U.S. Government Users Restricted Rights -- Use, duplication or disclosure restricted by GSA ADP Schedule Contract with IBM Corp.

This document was created or updated on August 16, 2010.

Send us your comments in one of the following ways:

- Use the online **Contact us** review form found at:
ibm.com/redbooks
- Send your comments in an e-mail to:
redbook@us.ibm.com
- Mail your comments to:
IBM Corporation, International Technical Support Organization
Dept. HYTD Mail Station P099
2455 South Road
Poughkeepsie, NY 12601-5400 U.S.A.

This document is available online at <http://www.ibm.com/redbooks/abstracts/tips0781.html> .

Trademarks

IBM, the IBM logo, and ibm.com are trademarks or registered trademarks of International Business Machines Corporation in the United States, other countries, or both. These and other IBM trademarked terms are US registered or common law trademarks owned by IBM at the time this information was published. Such trademarks may also be registered or common law trademarks in other countries. A current list of IBM trademarks is available on the Web at <http://www.ibm.com/legal/copytrade.shtml>

The following terms are trademarks of the International Business Machines Corporation in the United States, other countries, or both:

IBM Systems Director Active Energy Manager™
IBM®
Redbooks (logo)®
System x®

Other company, product, or service names may be trademarks or service marks of others.